



# TX

Forage transport wagons



TX EN

[www.krone.de](http://www.krone.de)



# KRONE TX

## Forage transport wagons



- Up to 56 m<sup>3</sup> (1,978 ft<sup>3</sup>) capacity (DIN 11741)
- Sloping steel floor at the front for increased machine capacity and stability
- Single frame design for a low dead weight and high payload
- Optional discharge rollers
- Flared tail- and headboards for easier and loss-free filling
- Articulated drawbar with hydraulic control lowers the machine's front end for a larger filling angle
- Extremely powerful roller chain to drive the chain-and-slat floor:  
Up to 34 m/min advance on the TX 460 and TX 560  
Up to 17 m/min advance on the TX 460 D and TX 560 D
- Double chain-and-slat floor uses 14x50 mm (0.6" x 2") round steel chains
- Conical load space for easy unloading
- Hydraulic auto-level axles







The TX range of forage transport wagons offers greater carrying and unloading capacities. The equipment for your success.

The body	4
Articulated drawbar	8
Models without discharge rollers TX 460, TX 560	10
Models with discharge rollers TX 460 D, TX 560 D	12
Optional equipment	14
Lights	16
Tandem axle	18
Tridem axle	20
Brakes and steering system	22
Operator Interfaces	24
Technical data	27



# KRONE TX

## Capacious volume

- Huge 46 m<sup>3</sup> (1,625 ft<sup>3</sup>) and 56 m<sup>3</sup> (1,978 ft<sup>3</sup>) capacities (DIN 11741)
- Single frame design and sloping bed for a low dead weight and high payload
- Robust, heavy-duty sides from solid steel
- Conical load space for easier unloading



### The innovative forage transport wagon

Rated to a gross weight of up to 31 tonnes, the KRONE TX forage transport wagons are designed for the heaviest work. These models boast such innovations as the sloping floor and flared head- and tailboards for greater intake capacities. The large opening at the top reduces the risk of losses and allows for easier filling whilst the flared tailboard makes the machine more

manoeuvrable. With the wagon being shorter at floor level than at the top, it is easier to avoid collision with fence posts. The articulated drawbar and sloping floor combine to optimize the load in the front area, shifting more weight to the tractor's rear wheels and thus improving traction.



# KRONE TX – the fast lane to success

The KRONE TX forage transport wagons tap into a decade long experience of manufacturing forage wagons and commercial trailers. Filling a KRONE TX from the forage harvester is as easy as it can get. Also, the machine offers a tremendous capacity and gives swift road travel as well as speedy unloading on the clamp. A benchmark in the industry, a KRONE TX cuts your costs and boosts your productivity.



## A KRONE exclusive

The bespoke single frame design with the sloping bed at the front reduces the machine's dead weight whilst increasing its payload. Its low centre of gravity provides TX with an enormous stability on the slope and when travelling around bends.

## Robust:

A 450 mm (1'6") ground clearance, lots of stanchions and extremely strong trapezoidal sheets make these wagons robust and heavy-duty equipment.



## Easier unloading

The conical body proves to be an excellent design, which offers a steel floor and side walls that widen to the rear for easy unloading. No nooks or crannies where material could collect. No stem is left on the machine.





# Boosting your productivity

Taking in more and unloading faster

- Sloping floor for more load space and better stability on slopes
- Improved traction for the tractor's rear wheels during the initial stage of loading
- Hard-wearing and grippy double chain-and-slat floor
- The floor is powered by a direct mechanical driveline
  - extremely powerful
  - extremely fast
  - not reliant on tractor hydraulics



## Larger load space

Launching the TX range, KRONE introduces a world-first innovation on a forage transport wagon – a sloping chain-and-slat floor. As the floor slopes to the front end, it forms a 'pocket', which collects the material that is flowing into the machine during the initial loading phase, thereby increasing the machine's overall capacity and the tractor's rear wheel traction. The low centre of gravity improves the machine's stability on the slope, both when working in the field as well as when travelling at speed on public roads.



## The chain tensioner

Perfectly tensioned chains make for a dependable crop feed to the rear and offer a longer service life. These low-maintenance chain tensioners with integral springs are integrated in the front end of the machine where they are easy to operate and service.



# Boosting your productivity

The KRONE TX models are tailored to the requirements of contracting companies.

Offering greater capacities from a sloping steel floor and swift unloading by powerful chains that do not rely on the tractor hydraulics, TX has become even more efficient. Set the benchmark and boost your profits – with a TX.



## Four chains

Two chain-and-slat floors ensure the material is unloaded smoothly and fast. Each of the four high-tensile and short-linked round steel chains are rated to a break load of 23 tonnes to advance at fastest speeds of up to 34 m/min. The box section chain slats provide an excellent grip on the material and a positive feed.



## Unloading in less than a minute

Using chains to drive the chain-and-slat floor offers the advantage of unloading huge masses of material in a minimum of time. The extra strong and low-maintenance 1 1/4" chain runs in plastic rails inside the frame and is extremely durable.



## Wide access door

Those TX models that feature discharge rollers come with a door on one side which is accessed via a foldable ladder. The wide door offers convenient access to the load area for easier cleanout.





## Ram controlled artic drawbar

Adapting to every situation

- Easy and loss-free filling into the lowered body – ideal when opening up fields
- Variable ground clearance for safe operation on the clamp and in deep ruts
- Slim drawbar for tight turns
- Hydraulic drawbar suspension for smooth ride



### Articulated drawbar with hydraulic control

The articulated drawbar makes for easier filling when following behind the forage harvester. As the wagon's front end tilts towards the tractor, the filling angle increases for loss-free filling from rear to front.

### Nimble

A TX forage transport wagon is very manoeuvrable. The slim drawbar gives tightest turns and easy shunting in confined space – the ideal equipment for opening up fields or clearing small plots.

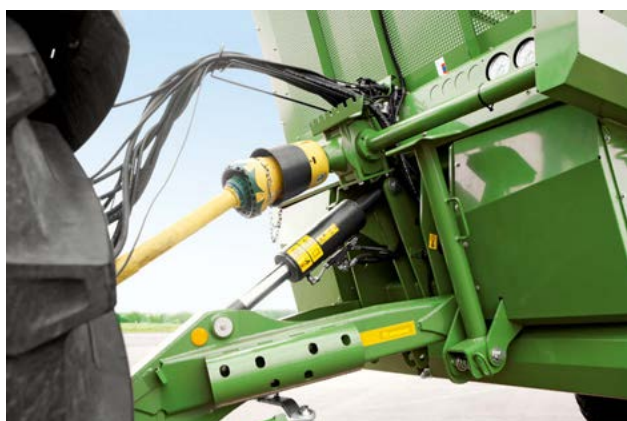



# A KRONE exclusive

The articulated drawbar with its hydraulic ram is a true innovation. The technology tilts the machine towards the tractor as this is following the forager, enabling easier filling. More than that, it increases the machine's ground clearance when it is travelling in deep ruts. The slim drawbar with ball hitch is nitrogen dampened and offers superior ride stability. The transparent headboard offers an excellent view of the load.



## Suspension for the drawbar

The drawbar's nitrogen tank is integrated in the oil circuit that supplies the articulated drawbar and absorbs shockloads for superior ride comfort.



## An ideal system

TX also features a foldable stand. The articulated drawbar adjusts hydraulically to the tractor's hitch height. It's easy.



## K 80 hitch ball

This hitch ball offers maximum operator comfort and minimizes wear on your equipment as the combination runs smoothly without jolting or experiencing shockloads. The K 80 ball hitch is rated to a 4,000 kg (8,818 lbs) tongue load.

# TX 460, TX 560

The models without discharge rollers

- Robust steel sides and extensions, few components
- Unloading takes less than a minute
- Powerful chain-and-slat floor with four chains



## Convenient

The flared tailboard makes for easy filling. The machine is shorter at floor level than at the top, which is a great boon when turning into narrow gates.

## Quick unloading

The powerful floor driveline advances the floor chains at 34 m/min so the machine takes less than a minute to unload. A TX is a true productivity booster.





# Harvesting faster

Featuring a sloping floor for extra volume and a single frame for a higher payload, the KRONE TX 460 and TX 560 are true forage specialists that add efficiency to your forage chain. A KRONE TX saves time and money.



## Controlled from the cab

The steel tailboard is operated automatically by two single-acting rams for convenient unloading without leaving the tractor.



## Pump it out

The TX460/TX560 tailboard opens wide and the double chain-and-slat floor advances at a rate of 34 m/min, unloading large masses of crop and smoothly and in no time at all.

# TX 460 D, TX 560 D

The models with discharge rollers

- Two powerful rotors unload the material in a uniform mat
- Rotor overload protection through the main driveshaft
- Fast fitting/removal of the entire assembly
- Fast unloading at a 17 m/min floor advance



## Discharge rollers

The TX 460 D and 560 D models have two discharge rollers as standard equipment. The large 450 mm (1'6") diameter rollers have grippy teeth in a spiral arrangement that spread the material uniformly and effectively across the full width.



## The heavy-duty driveline

The rotors are driven via the same sprocket that also drives the floor chains. The robust 1" chains transfer the full power to the discharge rollers and benefit from spring-loaded chain tensioners for smooth and dependable operation.





# Reaping success

The first step in making quality silage is to spread the material in a perfect mat on the clamp. The two discharge rollers on TX 460 D and TX 560 D unload the crop layer by layer, forming uniform mats for easy rolling. The powerful rollers are tuned to the advancing speed of the chain-and-slat floor. The assembly can easily be removed when not required in a specific job.



## Quick fitting / removal

The discharge rollers on the KRONE TX 460 D and TX 560 D models are easy and quick to remove as a single assembly.



## Fully protected

The direct driveline to the discharge rollers warrants dependable efficiency during the unloading process. The main driveshaft has an integral overload clutch that protects the rotors and allows even faster unloading.

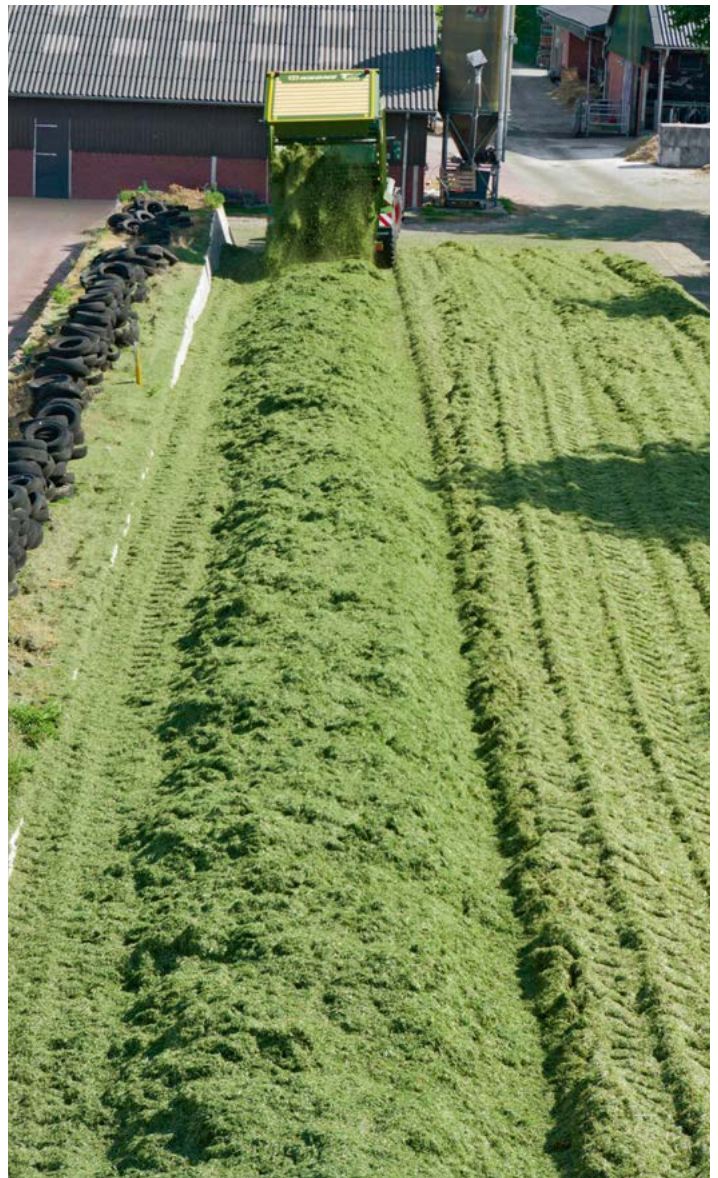





# Customize the machine to your needs

Plenty of options

- Optional ejector wall
- Optional lighting system
- Optional camera
- Optional weighing system
- Optional crop covers



## Effective material discharge

The mobile ejector wall at the front inclines and pushes the material until it topples, supporting the chain-and-slat floor in emptying the wagon fast and cleanly. It also prevents the crop face from tipping over to the front, thus eliminating the need for the usual extra sweep.

## Simple and effective

When the tailboard opens, the hydraulic mobile wall inclines, working in conjunction with the chain-and-slat floor to eject the load. As soon as the tailgate closes, the spring-loaded wall resumes its vertical position.





# Investment with a purpose



A reasonably specified machine helps you finish the job faster. KRONE developed a mobile ejector wall for its forage transport wagons that ensures the machine is emptied quickly and thoroughly. Further options include crop covers, weighing systems, extra lights and reflective contour markings which improve effectively the machine's functionality, safety and visibility.



## Level gauges

The pressure gauges indicate the current filling level. The gauges read out the pressure inside the cylinder on the articulated drawbar and inside the levelling rams on the axles. The filling level helps determine the weight of the crop.



## No crop is lost

Optional crop covers are available for all KRONE forage transport wagons to avoid crop being lost during road travel at speed. The covers open and close hydraulically.



## Electronic weighing system

The optional electronic weighing system uses sensor pins inside the drawbar and on the tandem/tridem axles that feature hydraulic levelling. The crop weight is the aggregate result of the load readings on the drawbar and axles.



## The crop in figures

The weight of the crop is read out on the display screen that comes with the optional weighing system. The weight of the unloaded crop is determined by the difference between the weight of loaded material and that of the material left on the machine.



# Night becomes day

## The KRONE lighting scheme

- Safe travel in the field and on the road
- Excellent all-round visibility at night
- High operator comfort in the field and on the clamp



### Exterior lights

KRONE TX forage transport wagons are available with up to four extra lights installed on either side for better visibility of axles and surroundings during shunting and travelling alongside the forager and also on the clamp.



### Double safety

The TX has two standard rear lights and a pivoting underride guard. This level of specification is standard on commercial trailers.





# See and be seen

Night work is a challenge for all operators on the harvest team and therefore KRONE offers an optional light kit that brings maximum safety to all operators involved in the campaign. An effective LED light inside the TX body, up to four external LED work lights and bright sidelights visible from far away, plus reflective contour markings as well as a camera with display screen combine to make those night shifts less fatiguing and much safer.



## Interior light

An optional and effective wall-mounted LED light illuminates the entire load area. The light is switched from the tractor's light control panel.



## Optional camera

An optional camera is available for all TX forage transport wagons. Its footage is shown on the colour display screen, providing enhanced visibility to the operator and making his job easier and safer.



## Visible from far away

LED sidelights and optional reflective strips mark the contours of the machine so other operators will recognize the full size of the machine from far away. An agricultural machine that is well visible in the dark allows motorists to adjust their driving and avoid a collision. The reflective contour markings offer enhanced safety on public and field roads.



## Great visibility

Additional rear combination lights including turn indicator light, rear light and brake light are mounted at the top of the tailboard for high visibility and early warning when making a turn.



# Tandem axle

## Hydraulic auto-levelling

- Anti-roll technology for best road stability
- Maximum stability on slopes  
Minimized risk of tipping
- Steered axles protect the sward from damage and the tyres from excessive wear



### Full adaptation

The axles provide for generous travel, distributing the load uniformly to the rear and front wheels at all times. They also offer excellent climbing and running on steep clamps.



### Maximum stability

The oil flows from the cylinder on the front wheel to the cylinder on the rear wheel and vice versa to compensate for undulations. The concept of using a separate oil circuit on each side of the machine but within the same axle assembly cuts out any risk of rolling and maintains the body level at all times.

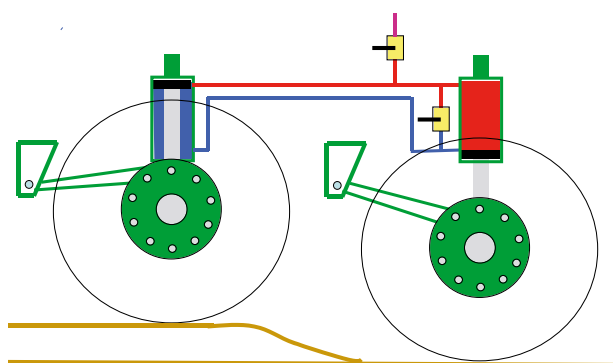

# On the road of success

Large wheels and high sides pose high demands on a forage wagon's running gear.

The caster-steer and forced-steer tandem axles offer hydraulic levelling to cater for all requirements and situations. Each assembly offers maximum roll stability during travel at speed and around bends. More than that, they provide great stability on the slope. These axles offer a maximum of safety and operator comfort.

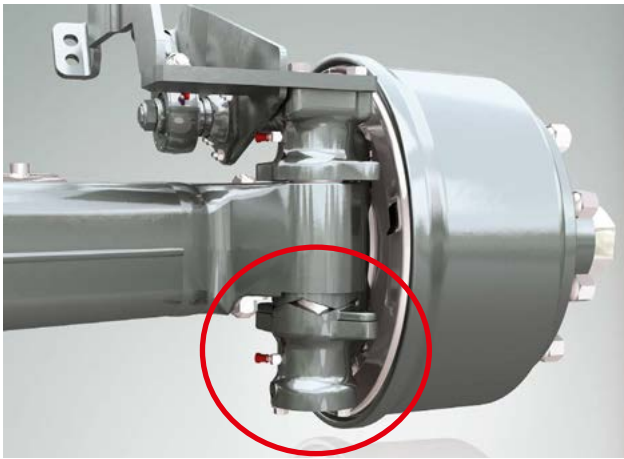

## Best straight travel

The cam discs on the stub axles are locked relative to the current load to give a maximum of road stability and safe turning. Deflection forces are lowest on the empty machine.

## Soft on the sward

The axle steering system is standard specification. Treading softly on the grass and pulling light in turns, the rear wheels are steered to reduce the wear on the tyres and the strain on the running gear.

## Flotation tyres

A choice of different treads and carcasses is available for the tandem axle tyres to provide the right match for every situation.



**Cross ply tyres**  
710/45 - 22.5 TL



**Radial ply tyres**  
710/50 R 26.5 TL



**Radial ply tyres**  
750/45 R 26.5 TL



**Radial ply tyres**  
800/45 R 26.5 TL





# Tridem axle assembly

## Hydraulic auto-levelling

- Tridem axles are standard on TX 560 and an option on TX 460 
- Up to 27,000 kg (59,524 lbs) axle load rating – 3 axles  
Up to 30,000 kg (66,138 lbs) technical load rating
- Superior operator comfort, great stability when stationary and moving
- Steered front and rear axle
- Lift-out front axle

### Excellent ride

The six wheels on the tridem assembly give soft treading and full adaptation to the ground. The hydraulic auto-levelling system actuates the rams on the individual

axles and distributes the load evenly to all six wheels. It is the split circuit technology that gives the machine its enormous roll and ride stability. The machine may be approved to 60 km/h (37 mph).





# Heavy duty



Heavy-duty axle assemblies are a requirement on a high-capacity machine that is designed for swift travels between field and clamp. The TX 460 and TX 560 models with tridem axles, bottom-mount K 80 ball hitches, a 31,000 kg (68,343 lbs) gross weight and a 40 km/h (25 mph) or 60 km/h (37 mph) maximum speed tick every box. The heavy-duty chassis features hydro-pneumatic suspension and hydraulic levelling to give superior operator comfort and stability.



## Lifting axle

The front axle can be raised hydraulically to save tyre tread during empty hauls.



## Steered wheels

A steered front or rear axle ensures excellent tracking in every curve for soft treading, low tractor input and less strain on the wheel bearings.



**Radial ply tyres**  
710/50 R 26.5 TL



**Radial ply tyres**  
750/45 R 26.5 TL



**Radial ply tyres**  
800/45 R 26.5 TL

## Soft on the ground

Select the 26.5" tyre of a brand that suits your application best. The light pulling flotation tyres give soft treading and leave few wheel marks.





# Brakes and steering

The highest level of safety

- Electronic EBS brake system features:
  - ALB load-sensitive brake power control
  - BS anti-lock brake system
  - RSS roll stability support
- Electronic forced steering



## The brakes

The TX 460 and TX 560 models are fitted with a standard dual-line air brake system. The hydraulic load-sensitive proportional valve controls the brake pressure relative to the load. The hydraulic brake system is an option in certain markets.

## Enhanced operational dependability

The optional electronic EBS brake system comprises ALB, ABS and RSS functions. The roll stability system intervenes by braking in a hazard situation, preventing TX from rollover when managing narrow bends at speed. All functions interact to provide safe operation.





# Better ride

As a leading manufacturer of commercial trailers, we know the ropes of the haulage industry. Ever bigger and faster tractors, ever higher trailer capacities and payloads call for a thorough rethink

of road and field safety. Therefore, KRONE offers an electronic brake system that has already proven its worth on our commercial trailers. Apart from that, intelligent steering axles are available to help protect the swath and provide added safety.



## Caster-steer axles

The TX 460 tandem-axle model is specified with standard caster-steer wheels that can be locked for shunting and clamping.

## Hydraulic forced steering

The tandem axle TX 460 has hydraulic forced steering as an option whereas this is standard equipment on the TX 560 tridem model. The system acts on the rear wheels on the tandem axle and on the front and rear wheels on tridem axles. The forced steering system offers a number of benefits: it stays activated when the machine is reversing; it takes out some of the pushing power that is necessary to make a turn; it also reduces the load on the running gear as well as optimizes the machine's running at speed. The system is controlled via the tractor's standard ball hitch and the master cylinder on the drawbar. A tridem axle assembly is steered by two master cylinders.

## Electronic forced steering

The electronically controlled forced-steer system has the axle controlled via the tractor's standard ball hitch, a steering rod and a sensor that senses the steering angle between tractor and wagon and sends the information to the axle steering system via the system's computer. This steering version uses a very compact linkage system which provides for better agility than the hydraulic system. The electronic system allows the operator to interfere with the shunting or steer manually when on the slope or during critical situations on the edge of the clamp. For operator safety, the intensity of steering starts decreasing when the machine's forward speed reaches 30 km/h (19 mph) and keeps dropping until it is zero at 50 km/h (31 mph).



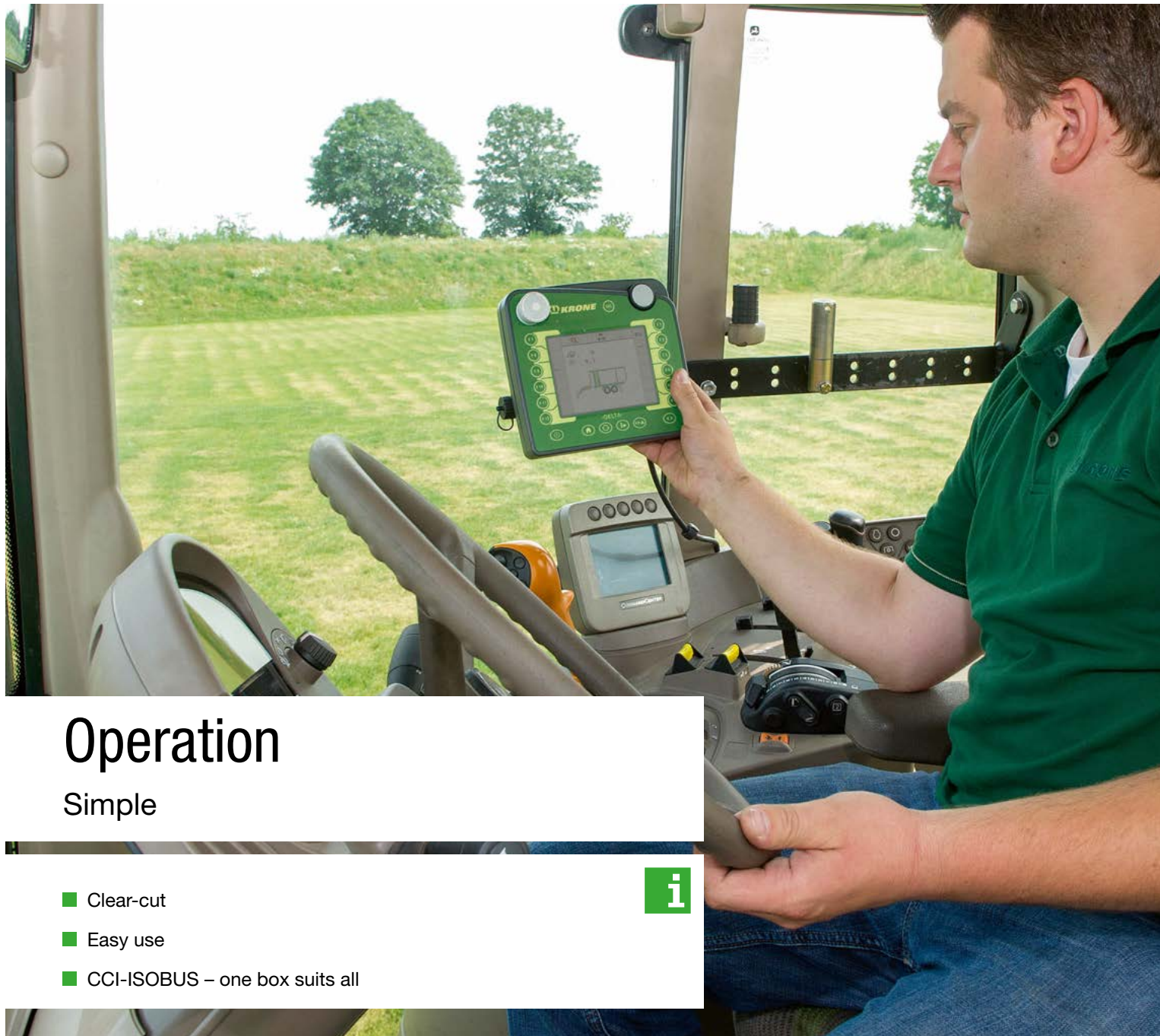

# Operation

Simple

- Clear-cut
- Easy use
- CCI-ISOBUS – one box suits all



**The base specification controls**

A base specification TX is operated solely from the tractor's spools which operate the tailboard, the articulated drawbar, the caster-steer tandem axle lock and the tridem lift axle. The optional ejector wall is controlled via the circuit that operates the tailgate whilst the optional crop covers require an additional double-acting spool.

# Self-explanatory and practical

A good user interface stands out for its clear and logical layout and menu. The system must be plausible and easy to use. The control units on the KRONE TX forage transport wagons meet all these requirements. Besides, a base specification TX requires no electronic system and no control box, because it is solely and simply operated via the tractor's hydraulic spools. Should you wish to specify optional equipment, such as the electronic weighing system or electronic axle steering, you can easily control these systems from a control box – either the Delta terminal, the CCI 200 ISOBUS terminal or the existing ISOBUS terminal on the tractor.



## Delta terminal

The Delta terminal is a requirement for the electronic weighing system and the electronic forced steering system. The backlit digital display screen provides an excellent overview of all machine functions. The operator can also choose to switch the optional work lights from this control box.



## The CCI 200 ISOBUS terminal

This operator terminal not only comprises all the functions that are available from our Delta control unit but is also compatible with third-party ISOBUS equipment. The keys benefit from active backlighting for enhanced operator convenience at night.



## ISOBUS tractor terminal

If your tractor has an ISOBUS compatible head unit, you can use that as a full substitute for the CCI 200 terminal.



## Spot on:

The flick switch operates those up to four optional LED work lights on the sides of the machine.





# Technical Data

## TX forage transport wagons

		TX 460	TX 460 D	TX 560	TX 560 D
Capacity DIN 11741	approx. m <sup>3</sup>	46 (1,625 ft <sup>3</sup> )	46 (1,625 ft <sup>3</sup> )	56 (1,978 ft <sup>3</sup> )	56 (1,978 ft <sup>3</sup> )
GVWR					
incl. tandem axle	kg (lbs)	24.000 (52,910)	24.000 (52,910)	–	–
incl. tridem axle	kg (lbs)	–	–	31.000 (68,343)	31.000 (68,343)
Drawbar tongue load	kg (lbs)	4.000 (8,818)	4.000 (8,818)	4.000 (8,818)	4.000 (8,818)
Gross axle weight					
Tandem axle model	kg (lbs)	20.000 (44,092)	20.000 (44,092)	–	–
Tridem axle model	kg (lbs)	–	–	27.000 (59,524)	27.000 (59,524)
Overall length	approx. mm	10.030 (32'11")	10.030 (32'11")	11.840 (38'10")	11.840 (38'10")
Total width*	approx. mm	2.900 - 2.960	2.900 - 2.960	2.900 - 2.960	2.900 - 2.960
Total height	approx. mm	4.000 (13'2")	4.000 (13'2")	4.000 (13'2")	4.000 (13'2")
No. of discharge rollers		–	2	–	2
Tandem axle		Standard	Standard	–	–
Caster-steer tandem axle		Standard	Standard	–	–
Forced-steer tandem axle		Option	Option	–	–
Available tyres for tandem axle models		710/45 R 22.5 TL (800/45 R 26.5 TL) (710/50 R 26.5 TL) (750/45 R 26.5 TL)	710/45 R 22.5 TL (800/45 R 26.5 TL) (710/50 R 26.5 TL) (750/45 R 26.5 TL)	– – – –	– – – –
Forced-steer tridem axle		–	–	Standard	Standard
Available tyres for tridem axle models		– – – –	– – – –	– 800/45 R 26.5 TL (710/50 R 26.5 TL) (750/45 R 26.5 TL)	– 800/45 R 26.5 TL (710/50 R 26.5 TL) (750/45 R 26.5 TL)
Bottom-mount drawbar		Standard	Standard	Standard	Standard
Hitch ball		Standard	Standard	Standard	Standard
PTO speed	r/pm	1.000	1.000	1.000	1.000
Chain-and-slat floor advancing speed	approx. m/min	34	17	34	17
Hydraulic couplers					
Drawbar and rear couplers		2 da	2 da	2 da	2 da
Hydraulic couplers					
Caster axle lock		1 sa	1 sa	–	–
Hydraulic couplers					
Lift axle		–	–	1 x EW	1 x EW
Weighing system		Option	Option	Option	Option
Covers		Option	Option	Option	Option
Power requirement	kW/hp	89/120	89/120	111/150	111/150

\* depending on tyres fitted

Specifications, weights and dimensions herein do not necessarily comply with standard specifications and are therefore not binding.



# KRONE Internet

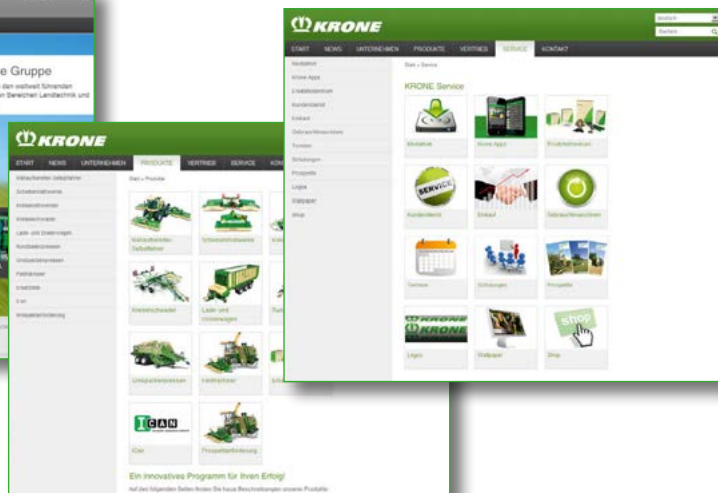

Discover the world at KRONE and browse through our website pages to find facts and figures and also new developments plus a wide range of services. Explore our website and find out how versatile the KRONE world is.



## News

Click here to find up-to-the minute information about KRONE – from new product presentations to show reviews. Here you are at the pulse of KRONE life.



## Products

Find extensive information on our full product range. This section holds everything you need – from video clips to manuals.



## Sales organisation

Here you find a distributor in Japan as well as your local KRONE dealer who will be pleased to support you. This is where you find your KRONE partner who will be pleased to assist you.



## Jobs

Would you like to join our company? KRONE is often looking for diligent and motivated staff to work at our farm machinery factory as well as at our commercial trailer production plant. So, this section is always worth a visit.



## Media center

The KRONE 'database' holds thousands of documents, pictures, test reports and much more. Here you find very detailed information on KRONE products that are of special interest to you.



## Events

Are you in for a KRONE live experience? Check out for KRONE events and look at a machine on show or watch it during a demonstration. After all, there is little that is more effective than a hands-on experience.



## Service

Here you find all the service information you require – from a point of contact at the factory to finance schemes for your KRONE machine as well as training schemes for staff and users.



## Download Center

Are you looking for a KRONE calendar for your desktop or a smart picture for your presentation? Here, at the KRONE download center, you will find plenty of useful material for a wide range of projects.



## Used Machinery

KRONE often has a wide range of demonstration or exhibit machinery on offer. This is a good site to find your KRONE machine. Then contact your local KRONE dealer to arrange the details of a potential purchase.



## Parts

24/7... This service gives you the opportunity to find your KRONE part at any time and without waiting. The KRONE Agroparts Portal has an article number and exact description for every part. You can order the part instantly at your local KRONE dealer by sending an e-mail to Agroparts.



## KRONE shop

Are you looking for a gift or are you a collector of farm models? Then you should definitely shop around at our KRONE shop. We take your orders at any time of the day.

Your KRONE dealer

## Maschinenfabrik Bernard KRONE GmbH

Heinrich-Krone-Straße 10  
D-48480 Spelle

Telefon: +49 (0) 5977.935-0  
Telefax: +49 (0) 5977.935-339

info.ldm@krone.de  
www.krone.de